

Data Sheet



Article number: 433000042

Description: Rota-fix shaft-hub connection C 42x48

Note: Not self centering. Small radial dimensions

Measures

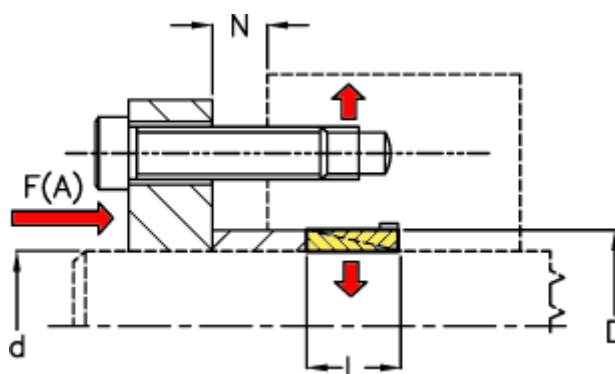

d mm = 42

D mm = 48

F(A) kN = 70

Fit tolerance = Aksel \varnothing ? 38 h6, Aksel \varnothing > 38 h8, Nav \varnothing ? 38 H7, Nav > \varnothing 38 H8

F kN torque = 12.0

L = 8

N1 = 4

N2 = 5

N3

N4

P N/mm² surface press

Surface roughness

T N m torque